

## SD30

### TROLLEY FOR MEDICAL COMPRESSOR DK50 DS

Trolley SD30 is intended for placing Compressor, Ventilator Device and Accessories. Mobility is provided for by sufficiently large wheels with a braking feature. The wide base guarantees the stability of the entire assembly.

Type: SD30  
 Supply No.: 602021222  
 Dimensions: 535x575x1054

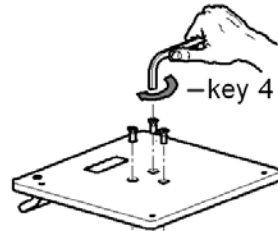

Maximal load-carrying capacity with load in the upper platte axis (1):

Trolley without compressor - 25kg \*  
 Trolley with compressor - 30kg

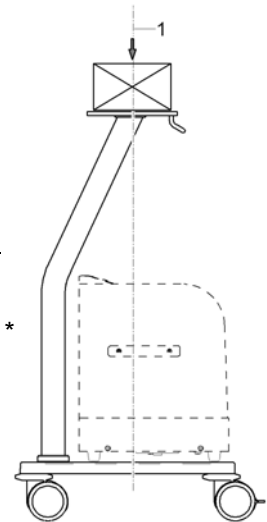

(\*) – According to EN 60601-1:2007, chap.9.4.2

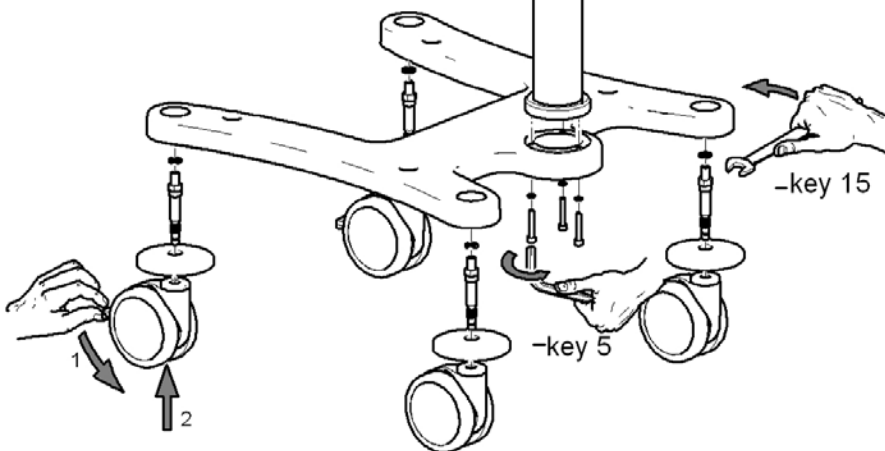





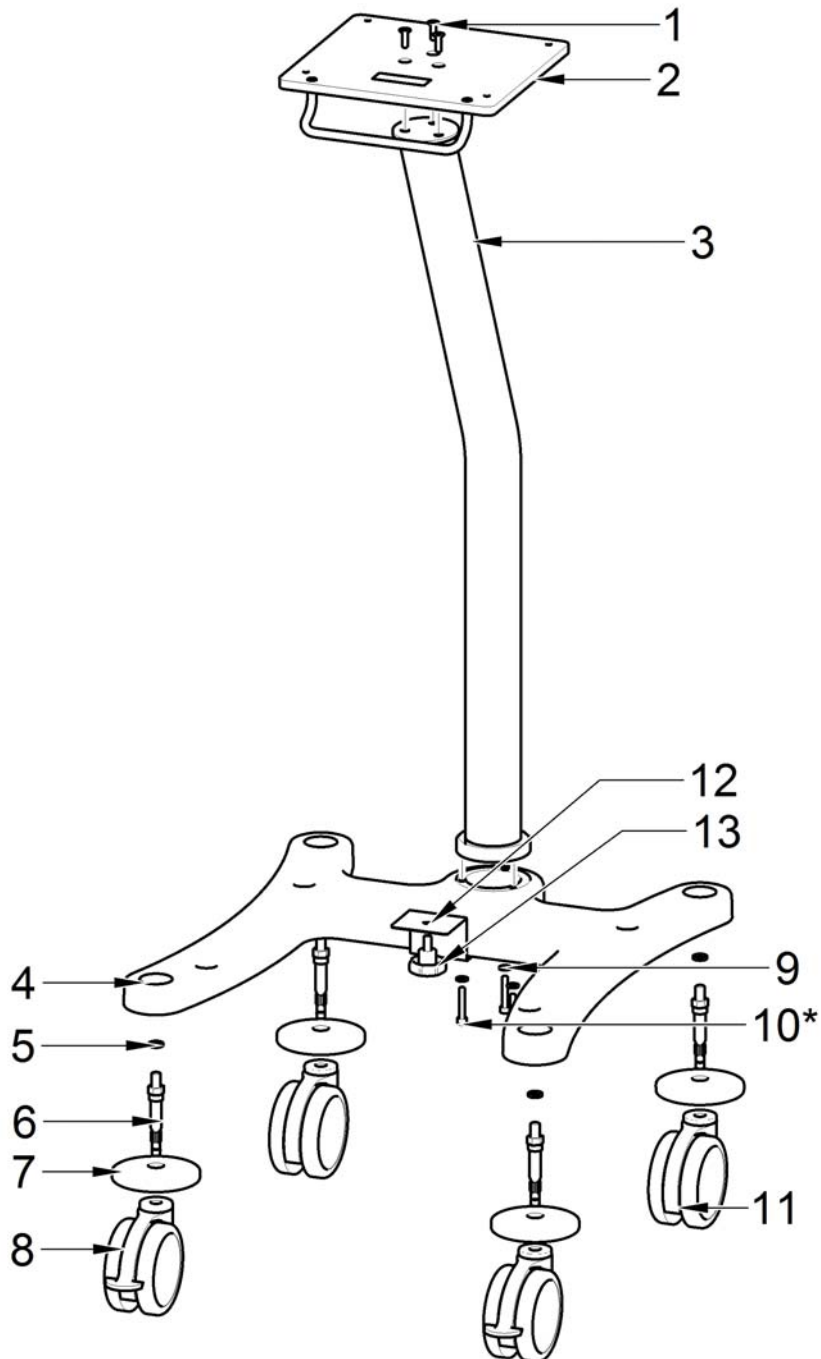



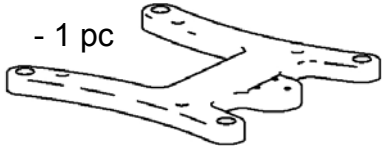

**The assessment of stability of the delivered assembly the part of which is trolley SD30 is the obligation of the assembly supplier. The manufacturer of the trolley bears no responsibility for damages caused by unreasonable load!**

## PARTS LIST

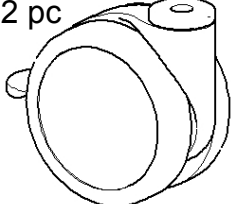

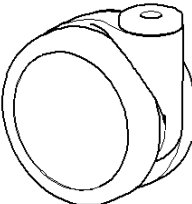
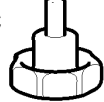
\*) - 17- 20 Nm - Tightening torque can be achieved by tightening with enclosed wrench nr. 5

- |                 |        |   |                   |        |   |
|-----------------|--------|---|-------------------|--------|---|
| 1 - Screw M6x20 | - 3 pc |    | 2 - Plate         | - 1 pc |    |
| 3 - Rod         | - 1 pc |    | 4 - Base          | - 1 pc |    |
| 5 - Washer 10   | - 4 pc |    | 6 - Fastener      | - 4 pc |    |
| 7 - Bumper      | - 4 pc |  | 8 - Wheel braking | - 2 pc |  |
| 9 - Washer D6,4 | - 3 pc |  | 10 - Screw M6x40  | - 3 pc |  |
| 11 - Wheel      | - 2 pc |  | 13 - Screw        | - 1 pc |  |
| 12 - Holder     | - 1 pc |  |                   |        |   |

13 - Key

4 - 1 pc  
5 - 1 pc



14 - Key

15- 1 pc

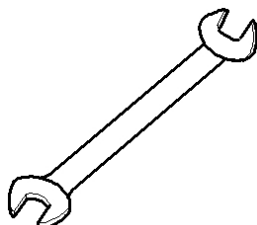

Z/885